

Application
Biology Teaching, Toxicity Testing
Embryo Research, Drug Screening

Zebra Fish Housing System

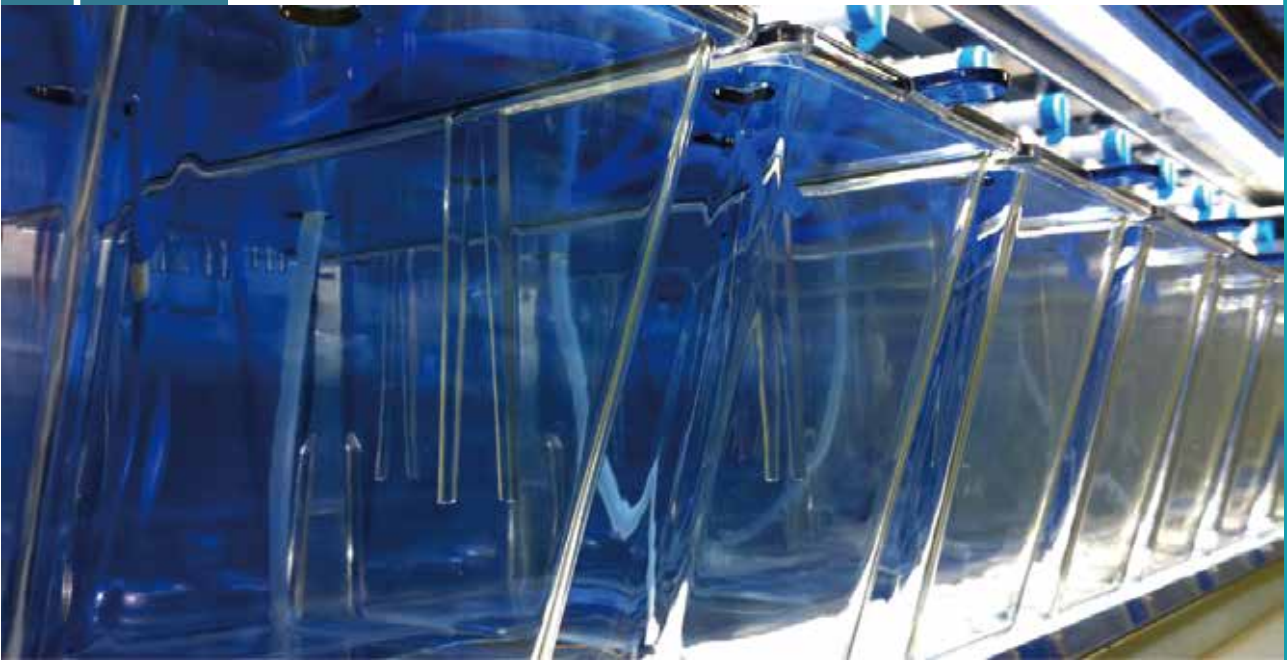

ZOONLAB

ZOONLAB provides complete service such as aquaculture system, filtration equipment, UV sterilizer, etc. We always focus on the development and manufacture of high-quality equipment and have a variety of customized services.

01

Zebrafish

Zebrafish is the animal model for genomic and develop research. There are many tissues and organ system are similar to human, eg. Heart, bones, pancreas and kidneys. The development of zebrafish embryos is particularly suitable for physical, chemical and gene engineering study. There are also significant benefits to using transgenic zebrafish at an environmental test. It is easy to breed, has strong fertility, and the genes have been completely decoded. It is a new animal model for vertebrate research and is widely loved by developmental biologists.

02

Animal Model

The zebrafish animal model is being developed for many human diseases, including the nervous system, hematopoiesis, and immune metabolic system. It also can be used for gene knockout and to enhance the discovery and research of new drugs. The transgenic zebrafish can be used as a drug screening model for specific diseases currently. It provides a good research tool and will become an increasingly important tool for drug screening. The gene is quite homologous to humans and there have many mimic human diseases model. The aquatic characteristics are convenient for direct dosing. It popular in cancer biology, genetics, toxicology, new drug development, etc. There are more labs have been established setting zebrafish system.

Control Switch Box

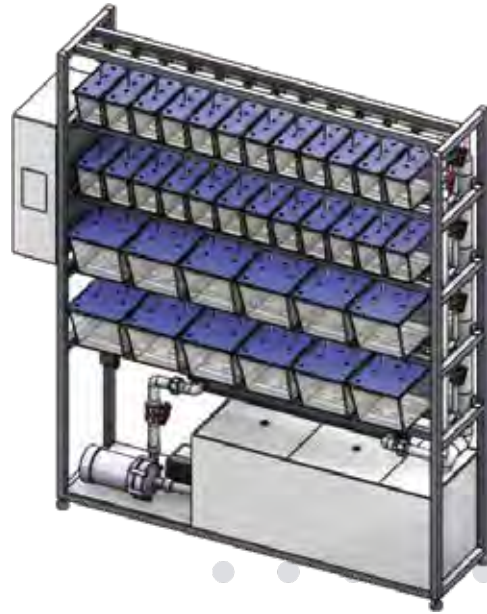
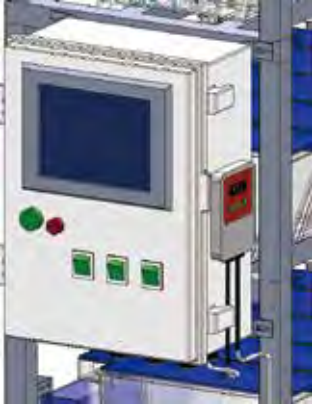

Circulatory System

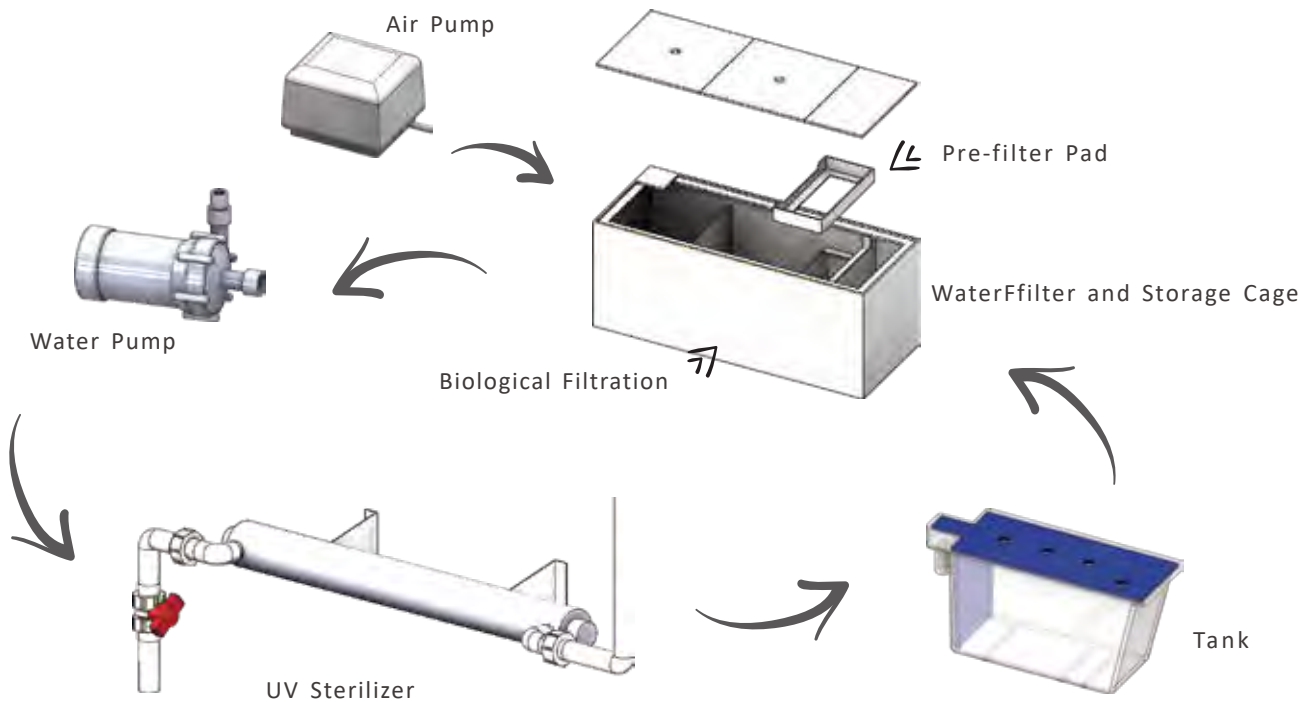

pH

EC



- Touch panel
- Basic function : flow pump control, air pump control, UV sterilizer control, light control, heater, timer
- Alarm : when system abnormal situation occurs, it will release an audible alarm
- Low water level alarm : when the water is below the setting level, it will stop water pump and heater running.
- UV Sterilizer. It is linked with water pump. When the water pump is off, the UV sterilizer can not be activated.
- Option function : pH/EC monitor or control system
- Custom-made system available.



Suitable for Remote Control,
Biological/Environmental Monitoring,
Big Data Analysis,
Multiple Device Management



CONTROL SWITCH BOX

- Material: polycarbonate (PC), it is for FDA approval food grade.
- Can auto-clavable
- The parts are movable and easy to clean and observe.
- There has a varied size tank, it can be selected according to the experimental.

01

CLASSIC - pipe

Size: 1.5L、3L、10L。

Features:

- Most common in the world.
- Easy to clean
- It good to use in drugtest by single
- Convenient to storage
- Water injection by pipe
- Suitable for small and medium fish



1.5 L



3L



10L



3L

1,5 L

Baffle for Larvae

02

NEW - pipeless

Size: 3L、4L、8L、10L。

Features:

- Water surface defoam function.
- Direct piped water can mix well with air.
- Circulation every 7 to 10 minutes can clean the excrement.



4L-Tubeless flow



8L-Tubeless flow



3L-Tubeless flow



10L-Tubeless flow

TANK

Fish tanks size comparison

Standard length

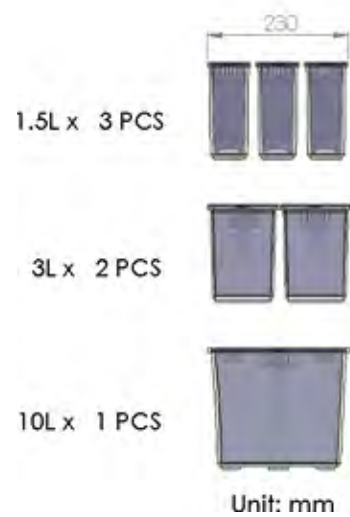
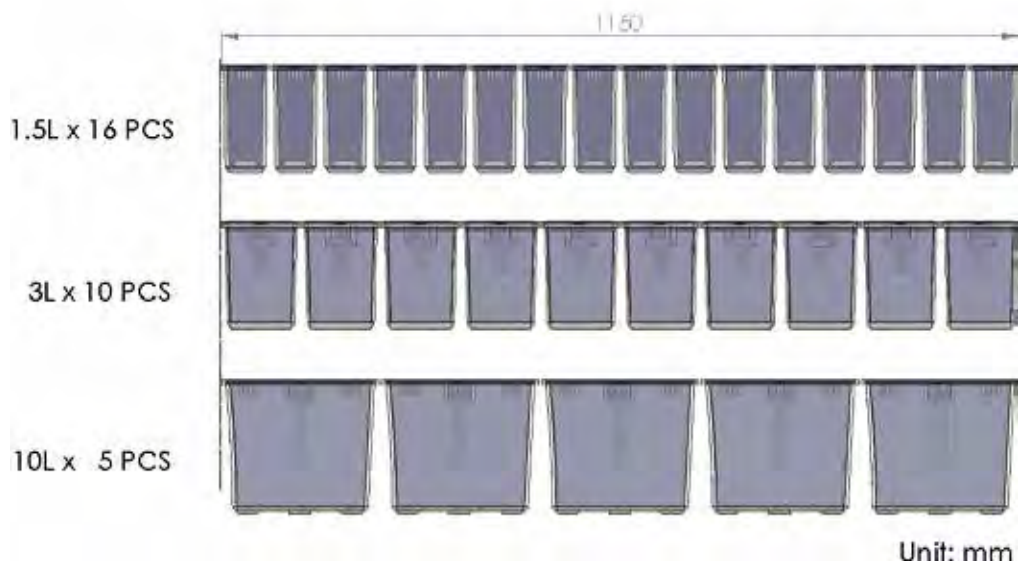
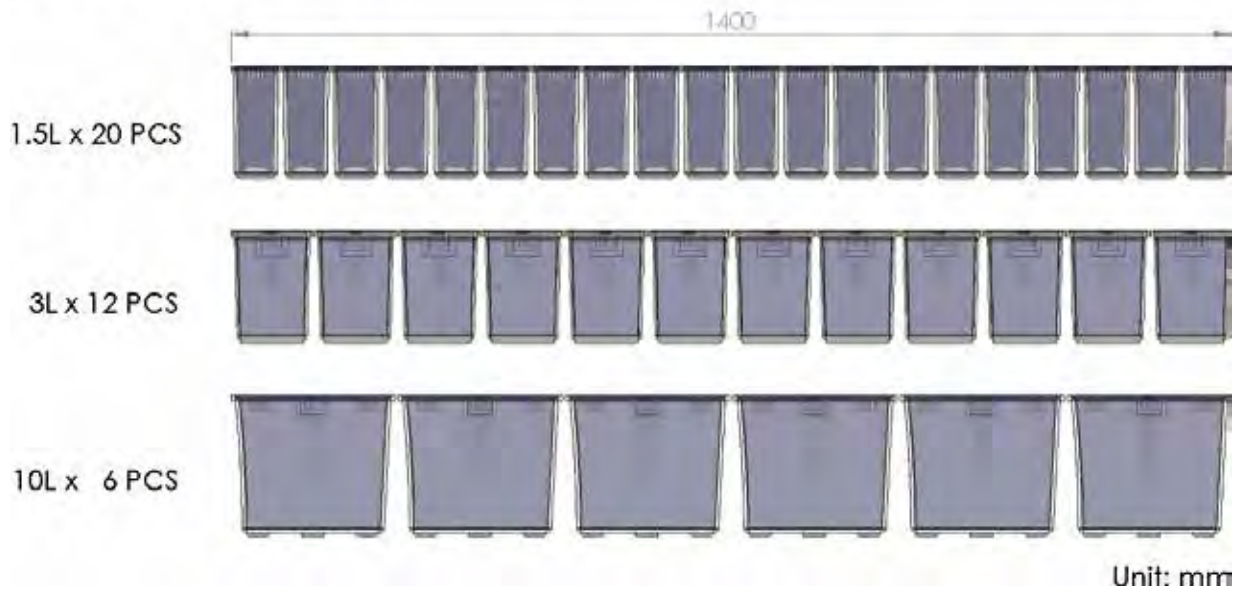

1.5L tank



3L tank



10L tank

MATING TANK SET

2L Mating Tank Water Yield: 1.5L

Features: It can use more fish to mating and can be used with the 3L tank.

Material: Polycarbonate (PC)

Outside Box: L 225mm x W 111mm x H 125mm

Inside Box: L 215mm x W 105mm x H 100mm

Kit Content: Outside box, Inside box, Lid, Baffles



1.2L Mating Tank Water Yield: 1L

Features: Less water for mating and can be used with the 3L tank.

Material: Polycarbonate (PC)

Outside Box: L 233mm x W 132mm x H 87mm

Inside Box: L 218mm x W 115mm x H 62mm

Kit Content: Outside box, Inside box, Lid, Baffles

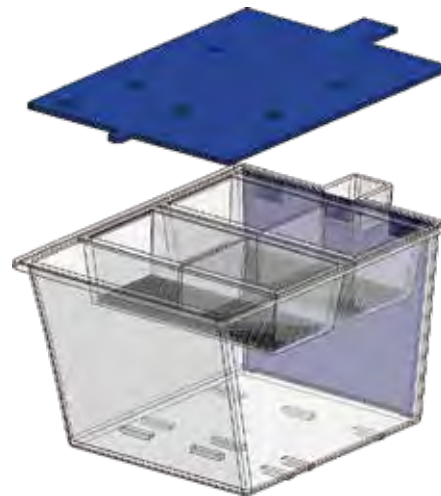

BIOLOGICAL FILTRATION

CALCIUM & MAGNESIUM ION Active Filter

Biological Filter Media 400 times greater decomposition rate while releasing beneficial trace element ions into the water

1. Provides functional substrate for bacterial colonisation.
2. Easily detached bio-membrane improves metabolism of beneficial bacteria.
3. Decomposes harmful matter such as organics and ammonia-nitrogen.
4. Releases important ions such as Ca_2^+ , Mg_2^+ , B_3^+ , Zn_2^+ , Li^+ and Al_3^+ , as supplement of nutrient



FAR INFRARED-RAYS ACTIVE FILTER

Improves water quality to enhance the health and vitality of aquarium fish.

1. Decreases the size of water molecules.
2. Promotes well-being and good metabolism in fish.
3. Supports good body colour and long-life of fish.
4. IR Radiation rate: Up to 85% at 4~12 μm .



ANION ACTIVE FILTER

Ionic Filtration By ionic charge, removes or neutralises suspended matter including free radicals and pathogens

1. Neutralises suspended solids & other factor conducive to pathogens, providing clarified water.
2. Detoxifies free radicals, promoting good fish metabolism.
3. Provides superior conditions, allowing fish to develop good disease resistance, wound cure, life-span etc.
4. Mineral anion radiation effects reach 6500~7500 ea/ml.



QUARTZ MEDIA RINGS

The Quartz Ball has an enormous porous surface area for intensive bacterial colonization. Made from natural lava rock processed under high temperatures, this media can be used in the biological filtration system of both fresh and saltwater aquariums.



FEED



Vitellus
for 1w~3w

Decapsulated Brine shrimp eggs
for 2w~4w

Feed
for adult



Brine shrimp eggs
for adult



2 liter Harvest shrimp hatchery
(Hatch max: 15~20 gram brine shrimp eggs)

SYSTEM

THE BEST SOLUTION FOR SMALL SIZE LABORATORIES

- Suitable to be used in a cramped space.
- The optimal choice for quarantine, segregation and the small quantity of breeding.
- Equipped with well-prepared and stand-alone circulation and filtration system.
- Option side-mounted filtration system.
- Custom-made system available.
- Standard Configuration :
Touch panel control system, Water pump, Air pump, Pre-filter pad, Biological filtration (option:ceramics bio-media ,Magnesium Ion Filter ,Far Infrared Rays Filter ,Anion Filter , Coral gravels cartridge), UV sterilizer, Heater
- pH/EC monitor or control system

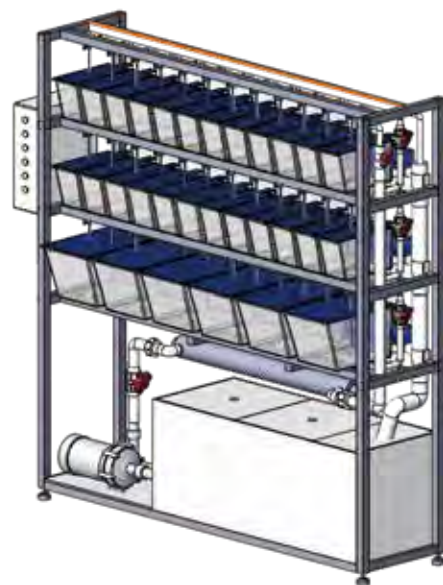

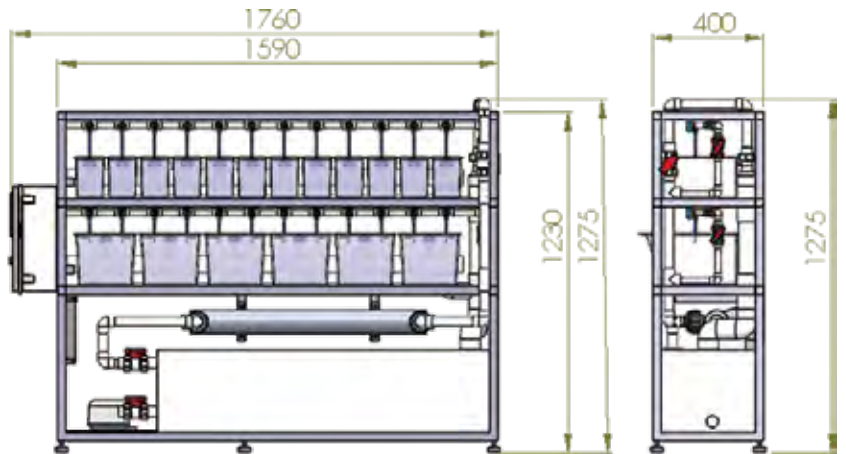
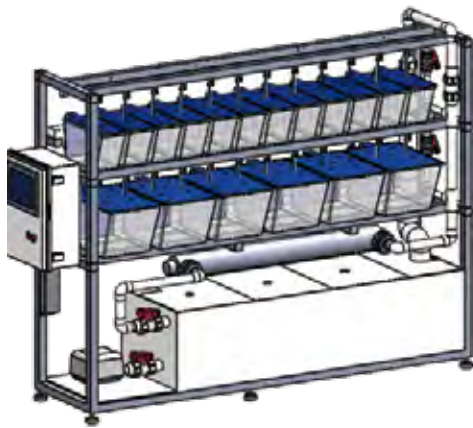

CL-201-1

HMI Controller
pH., Cond., Temp. Monitor

UV Ster. x 1 PCS
Water Pump x 1 PCS
Air Pump x 1 PCS

3L x 12PCS
10L x 6 PCS

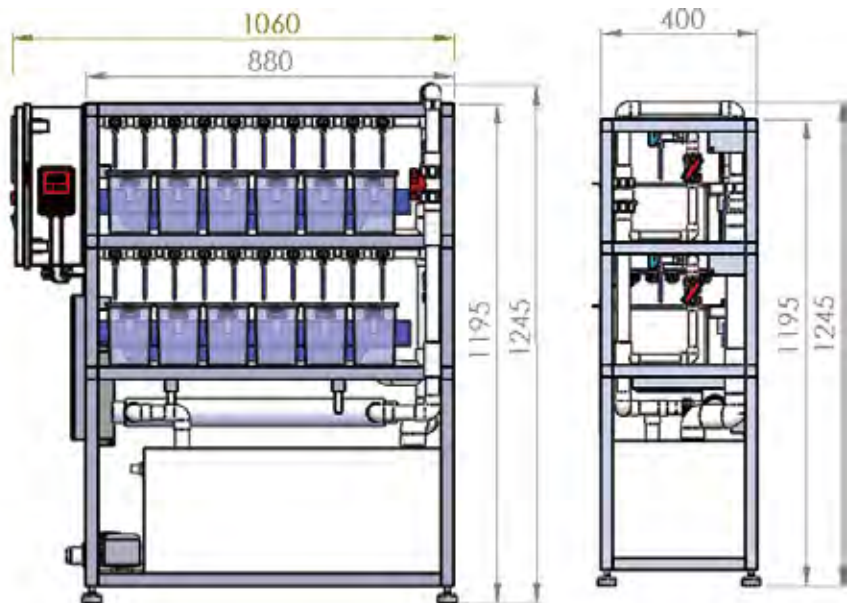
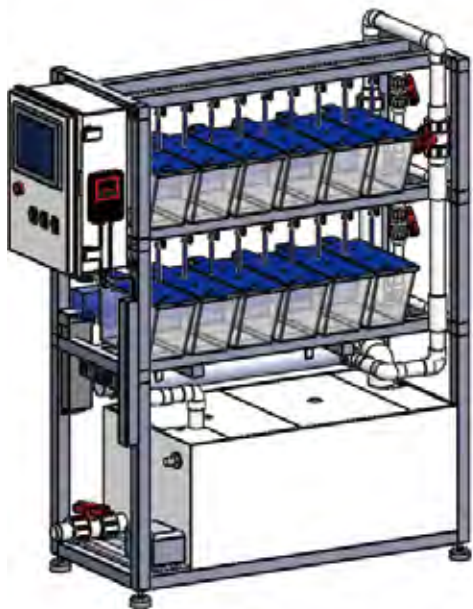

CL-206-2

3L x 12PCS

HMI Controller
pH., Cond., Temp. Monitor

UV Ster. x 1 PC
Water Pump x 1 PC
Air Pump x 1 PC
Heater x 1 PC

2 TIER

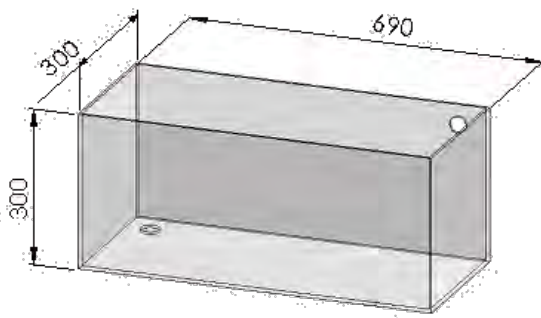
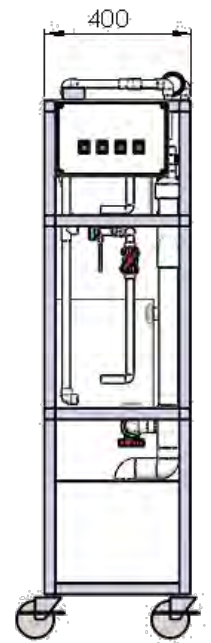
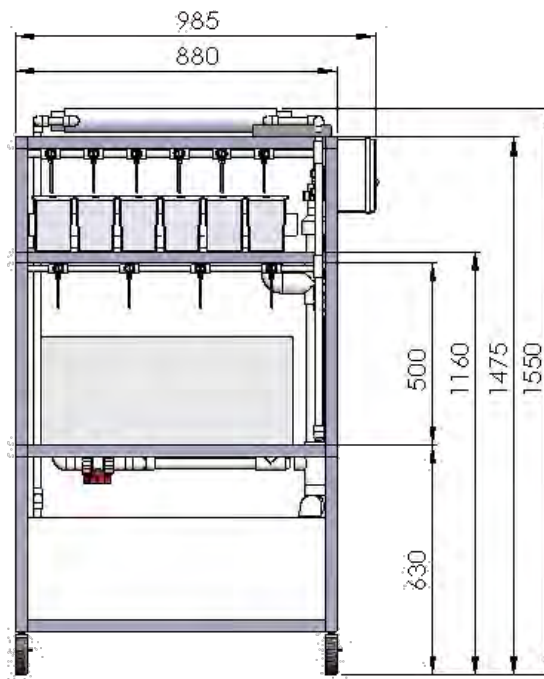
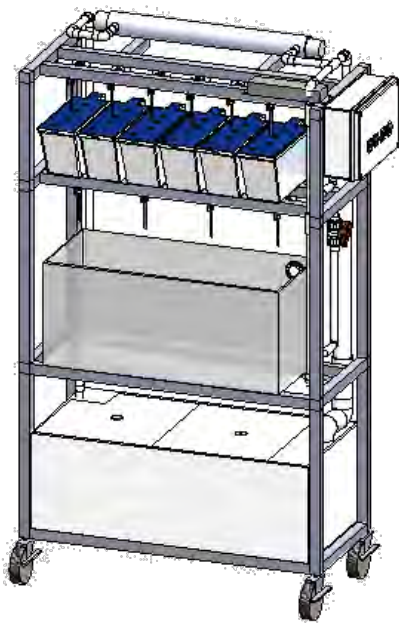

CL-206H

50L Glass tank with bottom and overflow design
(690x300x300) x1 PCS

3L PC tanks x6 PCS

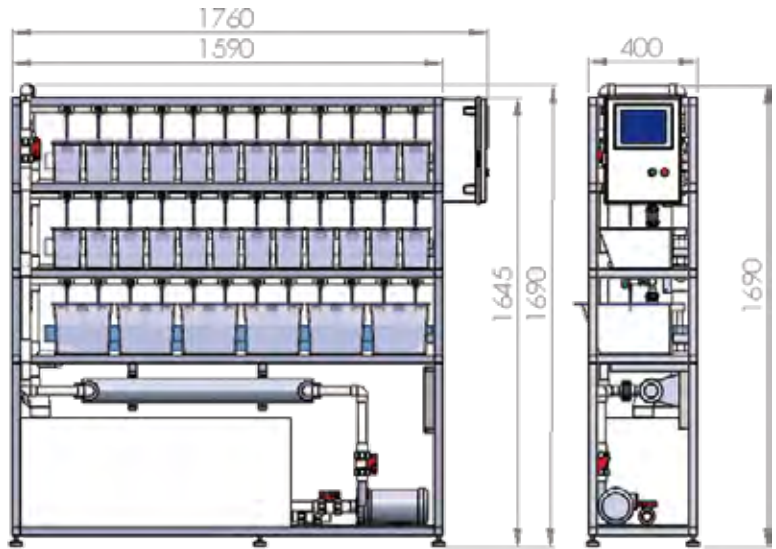
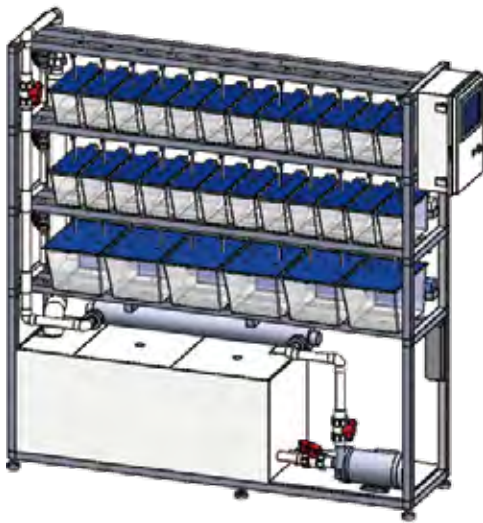

CL-301-1R
 HMI Controller
 pH., Cond., Temp Monitor

UV Ster. x 1 PCS
 Water Pump x 1 PCS
 Air Pump x 1 PCS

3L x 24 PCS
 10L x 6 PCS

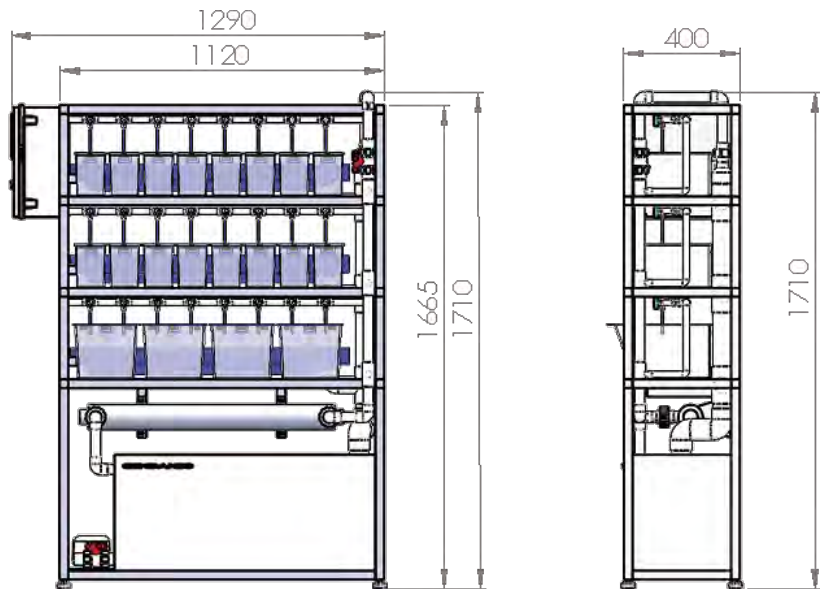
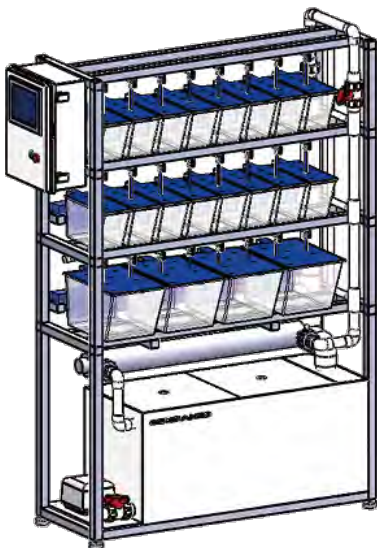

CL-303-1
 HMI Controller
 pH., Cond., Temp. Monitor

UV Ster. x 1 PCS
 Water Pump x 1 PCS
 Air Pump x 1 PCS

3L x 16 PCS
 10L x 4 PCS

3 TIER



CL-306-1
 1.5L x 10 PCS
 3L x 6 PCS
 10L x 3 PCS

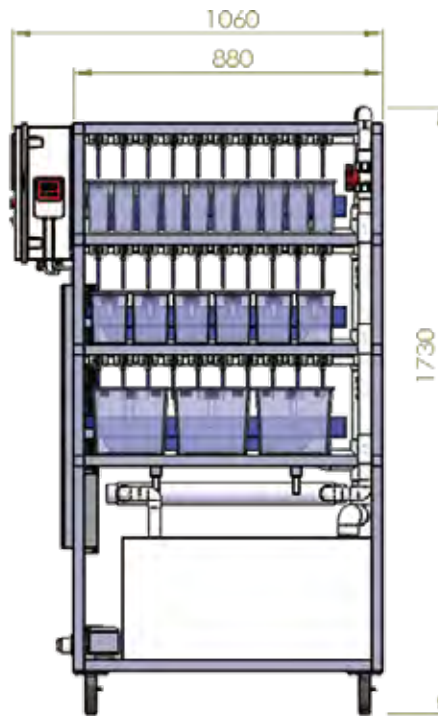

HMI Controller
 pH., Cond., Temp. Monitor

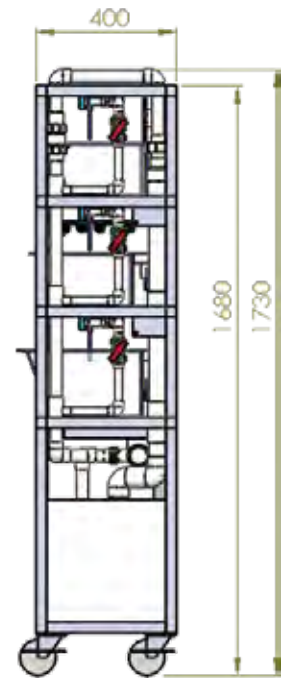

UV Ster. x 1 PC
 Water Pump x 1 PC
 Air Pump x 1 PC
 Heater x 1 PC

STAND ALONE HOUSING SYSTEM

- Suitable for laboratory scale application.
- Able to undertake quarantine, breeding, and reproduction.
- Equipped with well-prepared and stand-alone circulation and filtration system.
- All filters can be changed without turning off the system.
- An independent water inlet valve is mounted to every layer of the rack and each fish tank.
- Option side-mounted filtration system.
- Custom-made system available.
- Standard Configuration :
 - Touch panel control system, Water pump, Air pump, Pre-filter pad, Biological filtration (option:ceramics bio-media ,Magnesium Ion Filter ,Far Infrared Rays Filter ,Anion Filter , Coral gravels cartridge), UV sterilizer, Heater
- pH/EC monitor or control system

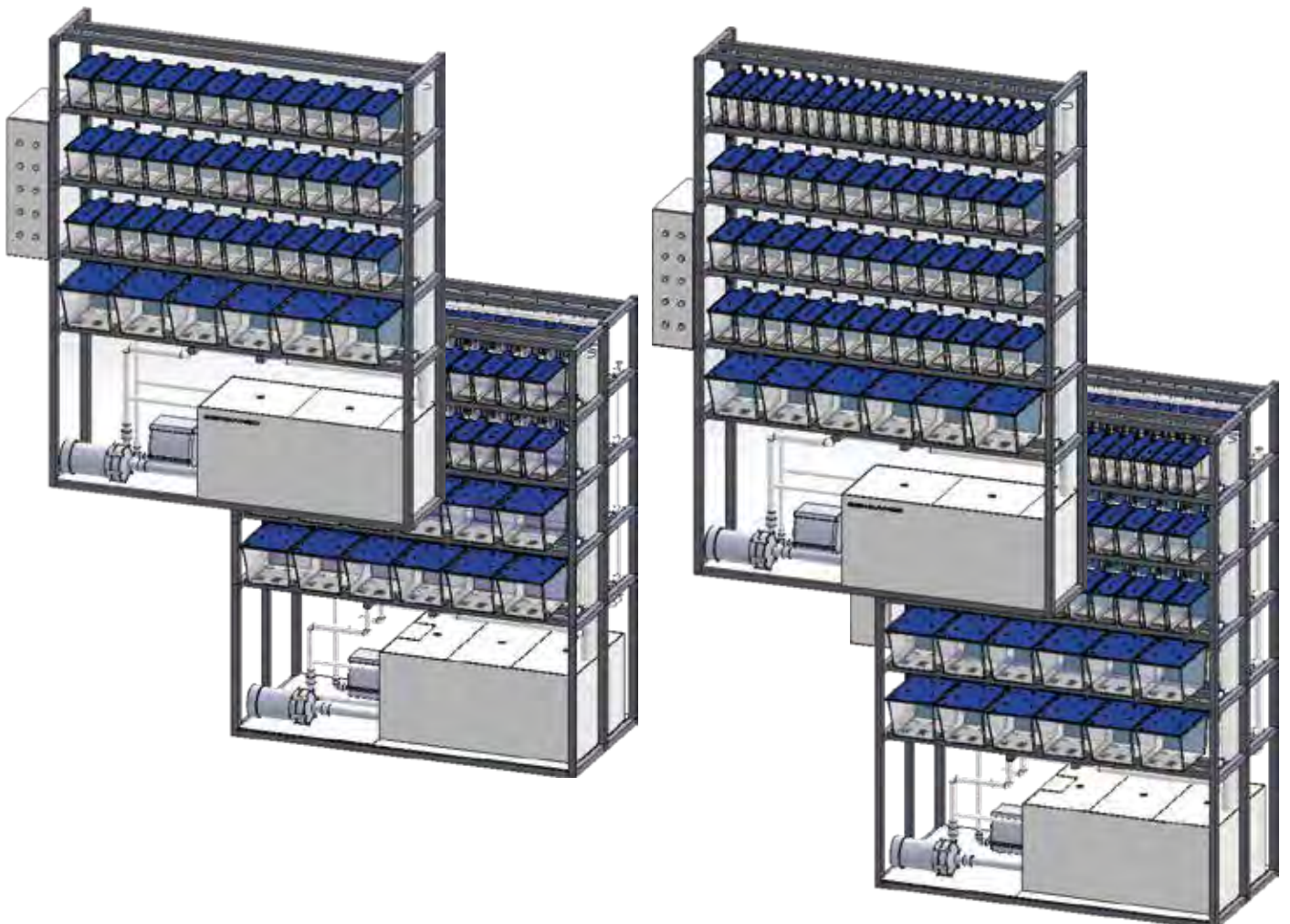

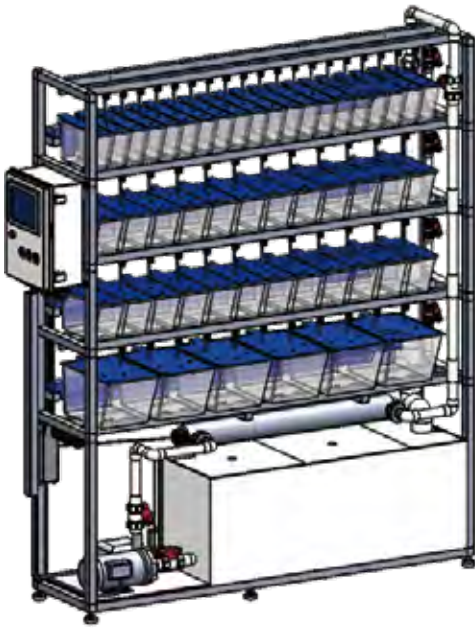

CL-401-1

1.5L x 20 PCS
3L x 24 PCS
10L x 6 PCS

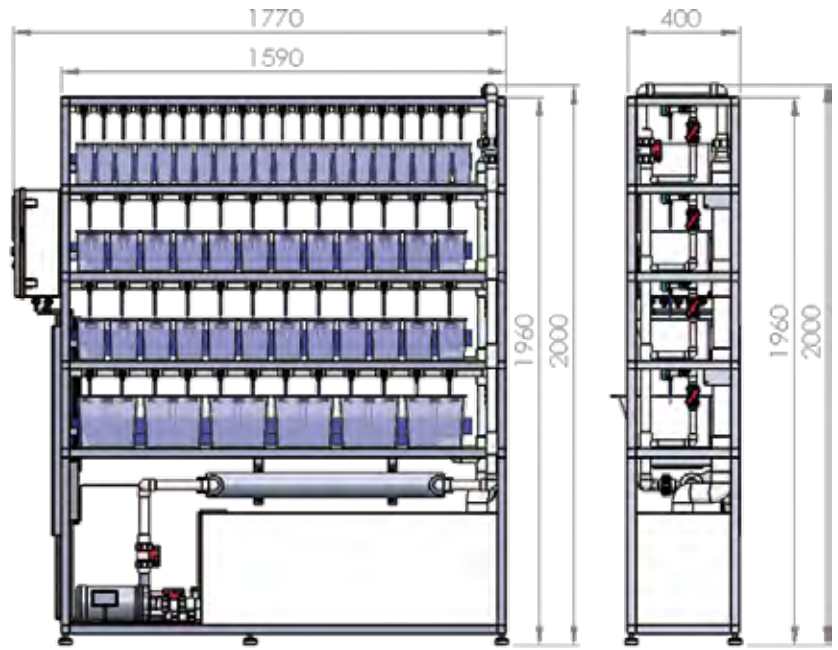

HMI Controller
pH, Cond., Temp Monitor

UV Ster. x 1 PC
Water Pump x 1 PC
Air Pump x 1 PC
Heater x 1 PC

4 TIER

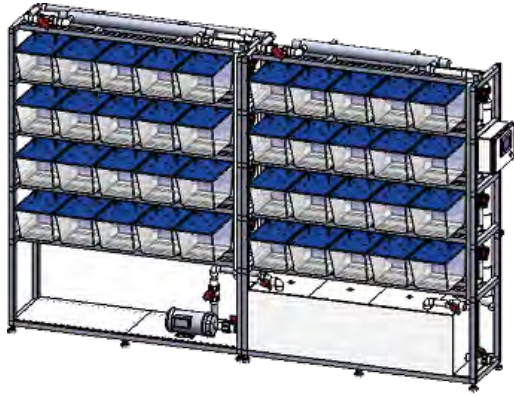

CL-402LExt-C1

HMI Controller
pH, Cond., Temp Monitor

10L x 40 PCS

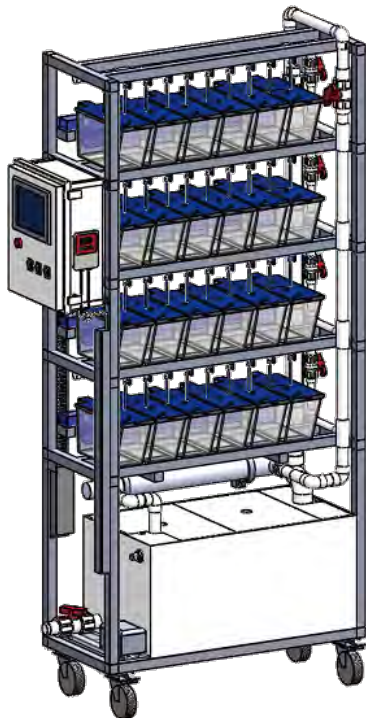
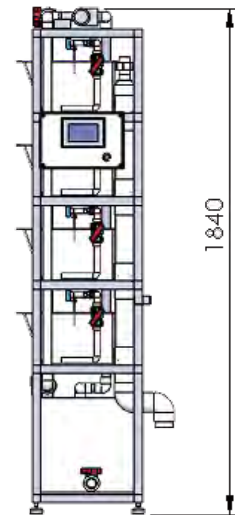
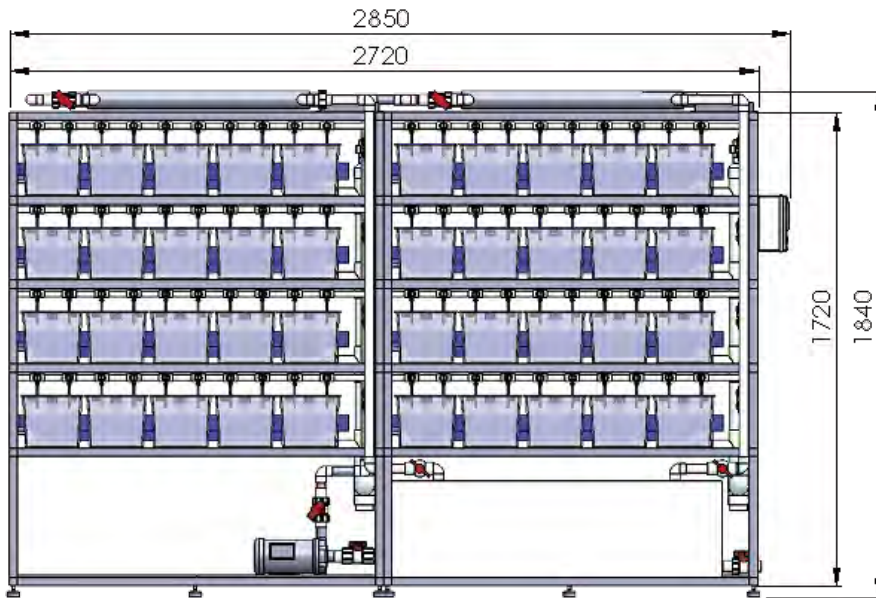

CL-406-4

3L x 24 PCS

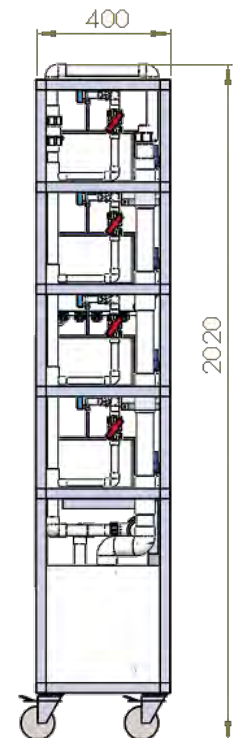
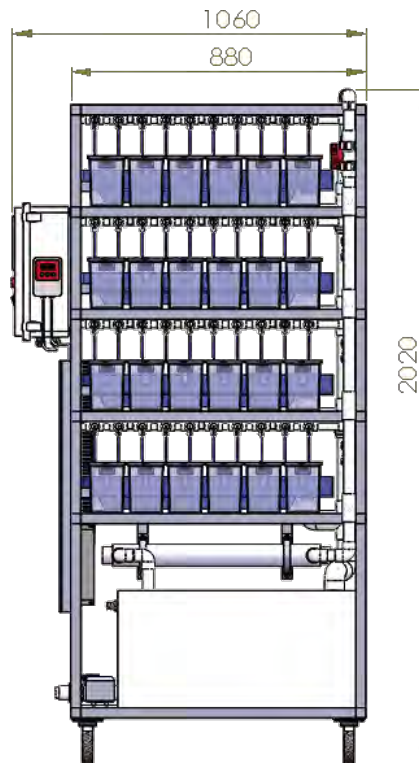

HMI Controller
pH., Cond., Temp. Monitor

UV Ster. x 1 PC
Water Pump x 1 PC
Air Pump x 1 PC
Heater x 1 PC

5 TIER

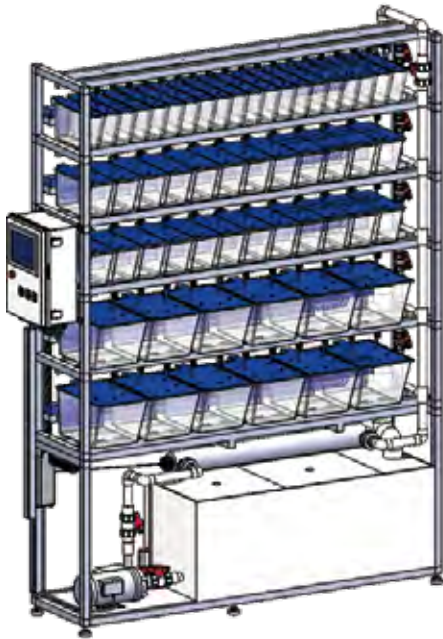

CL-501-1
 1.5L x 20 PCS
 3L x 24 PCS
 10L x 12 PCS

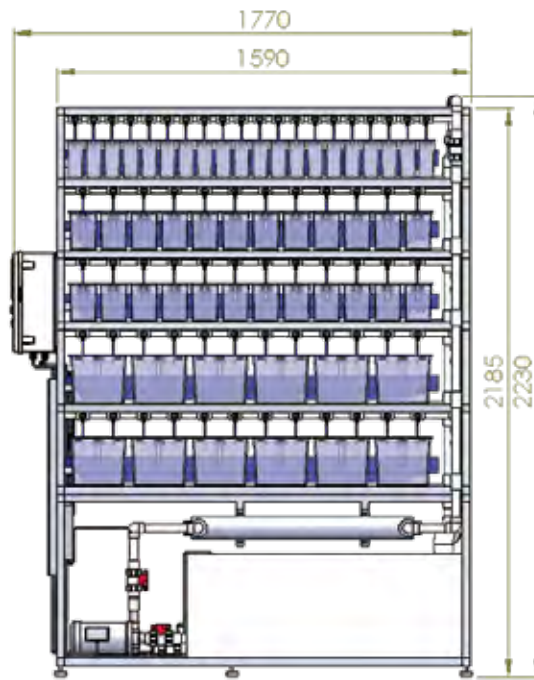

HMI Controller
 pH, Cond., Temp Monitor

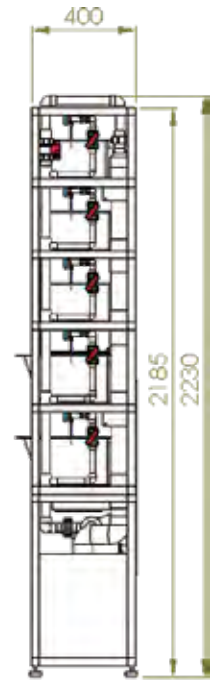

UV Ster. x 1 PC
 Water Pump x 1 PC
 Air Pump x 1 PC
 Heater x 1 PC

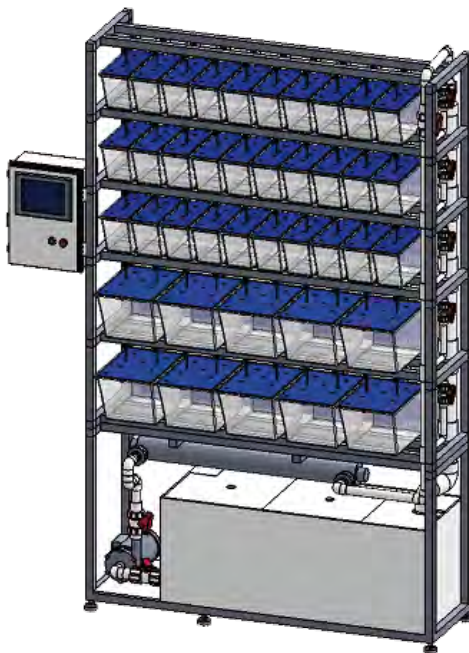

3L x 10 PCS
 10L x 10 PCS

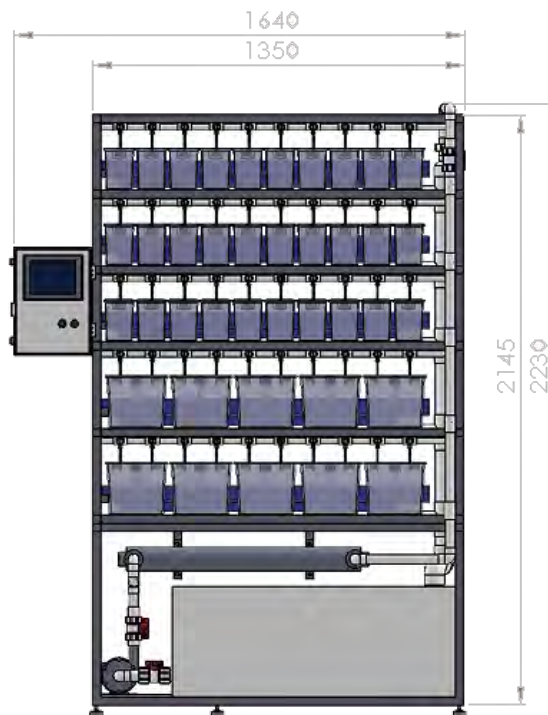

CL-502-C1
 HMI Controller
 pH, Cond., Temp Monitor

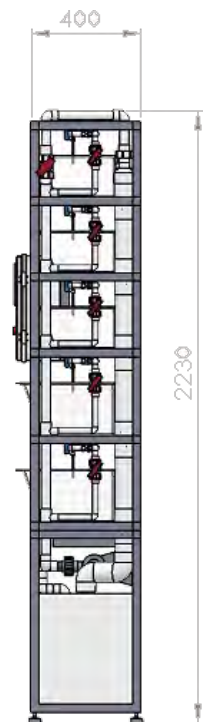

MULTI-CONNECTING HOUSING SYSTEM

- Extra large water sump design, able to maintain a stable water quality.
- Suitable for mass breeding.
- Suitable for screening when the tank of a system all using the 1.5L tank.
- Equipped with well-prepared and stand-alone circulation and filtration system.
- All filters can be changed without turning off the system.
- An independent water inlet valve is mounted to every layer of the rack and each fish tank.
- Option side-mounted filtration system.
- Custom-made system available.
- Standard Configuration :
 - Touch panel control system, Water pump, Air pump, Pre-filter pad, Biological filtration (option:ceramics bio-media ,Magnesium Ion Filter ,Far Infrared Rays Filter ,Anion Filter , Coral gravels cartridge), UV sterilizer, Heater
- pH/EC monitor or control system

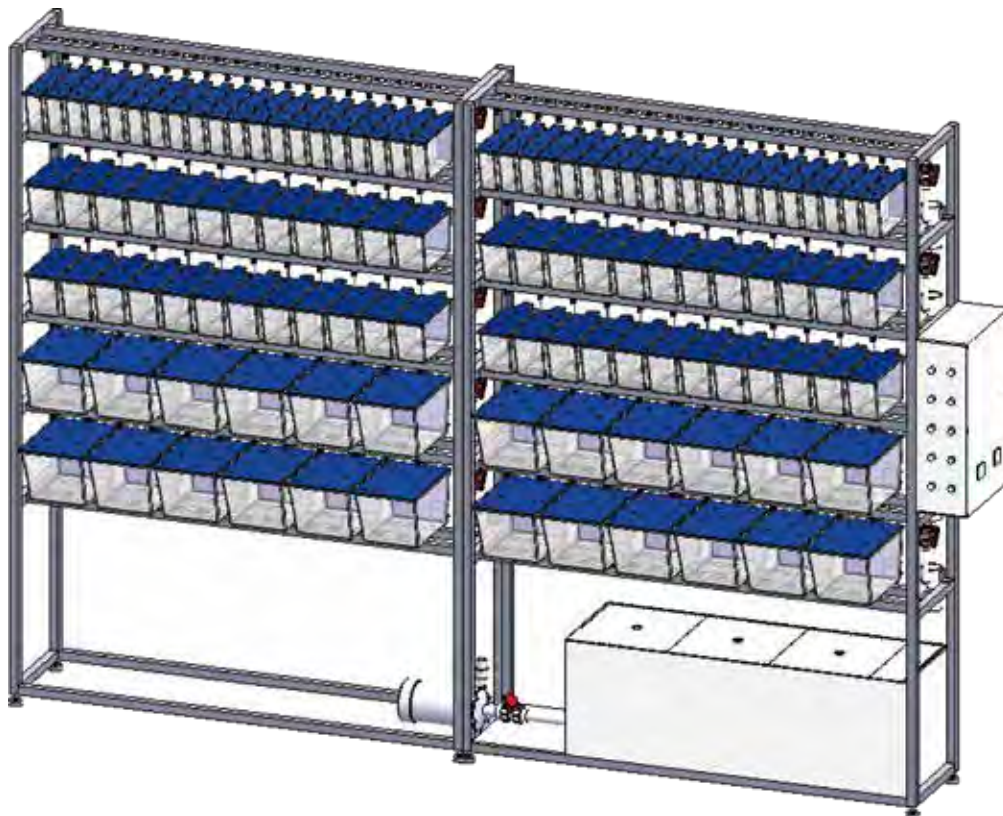

MULTI

INFECTION SYSTEM

- The system no recirculation that suitable for infection experiment.
- The tank's water will be directed throughout by drainage channel to prevent the infection test affection each other.
- An independent water inlet valve is mounted to every layer of the rack and each fish tank.
- Custom-made system available.
- Standard Configuration :
Touch panel control system, Water pump, Air pump, UV sterilizer, Heater

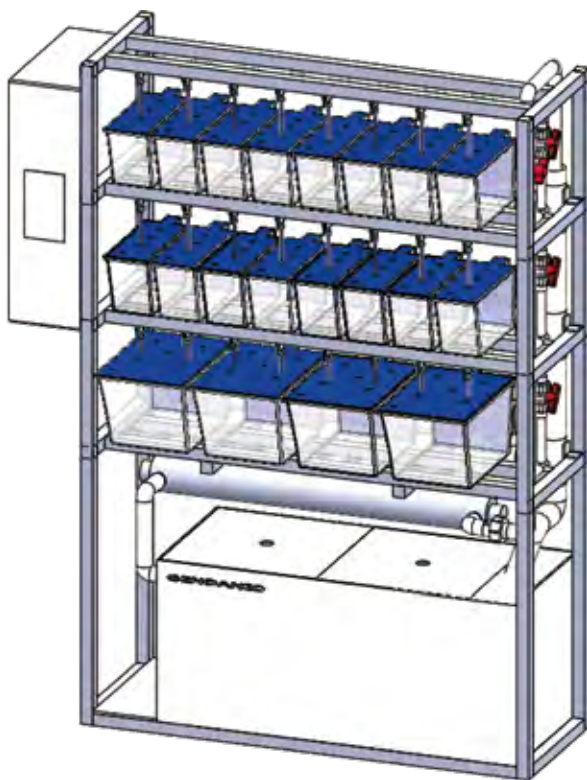

Direct exclude the wastewater

Circulation

Size: W115±3 × D40±1 × H165±3 cm (W/O control box)
W135±3 × D40±1 × H165±3 cm (W/ control box)
tank: 3L tank×16, 10L tank×4
Electrical: 110~220V/50~60Hz

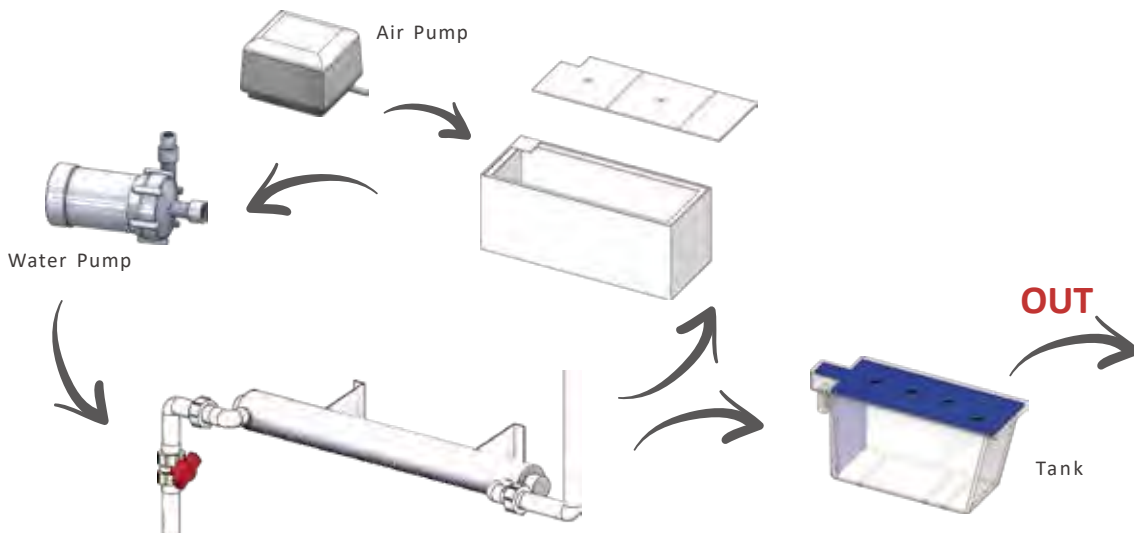

XENOPUS AND MIDE-SIZE FISH HOUSING SYSTEM

- Large display window for a clear viewing of fishes.
- Equipped with well-prepared and stand-alone circulation & filtration system.
- Low water level alarm for water sump.
- Rack material : stainless steel #316, corrosion-resistant.
- Fish tank material : PP, corrosion-resistant.
- Independent water inlet valve.

Xenopus and Mid-size Fish Housing System

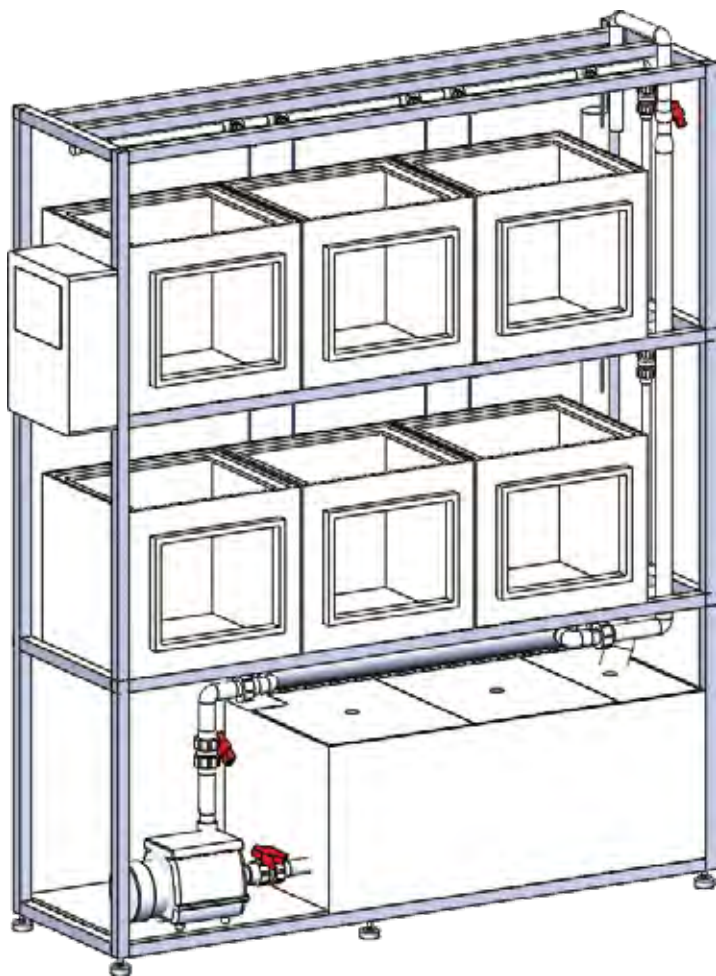

Size: 176 x 63 x 194 cm

Tank : 96L x 4 tanks

Standard Configuration :

Water pump, Air pump, Pre-filter pad, Activated carbon filter, Coral gravels, UV light, Heater.



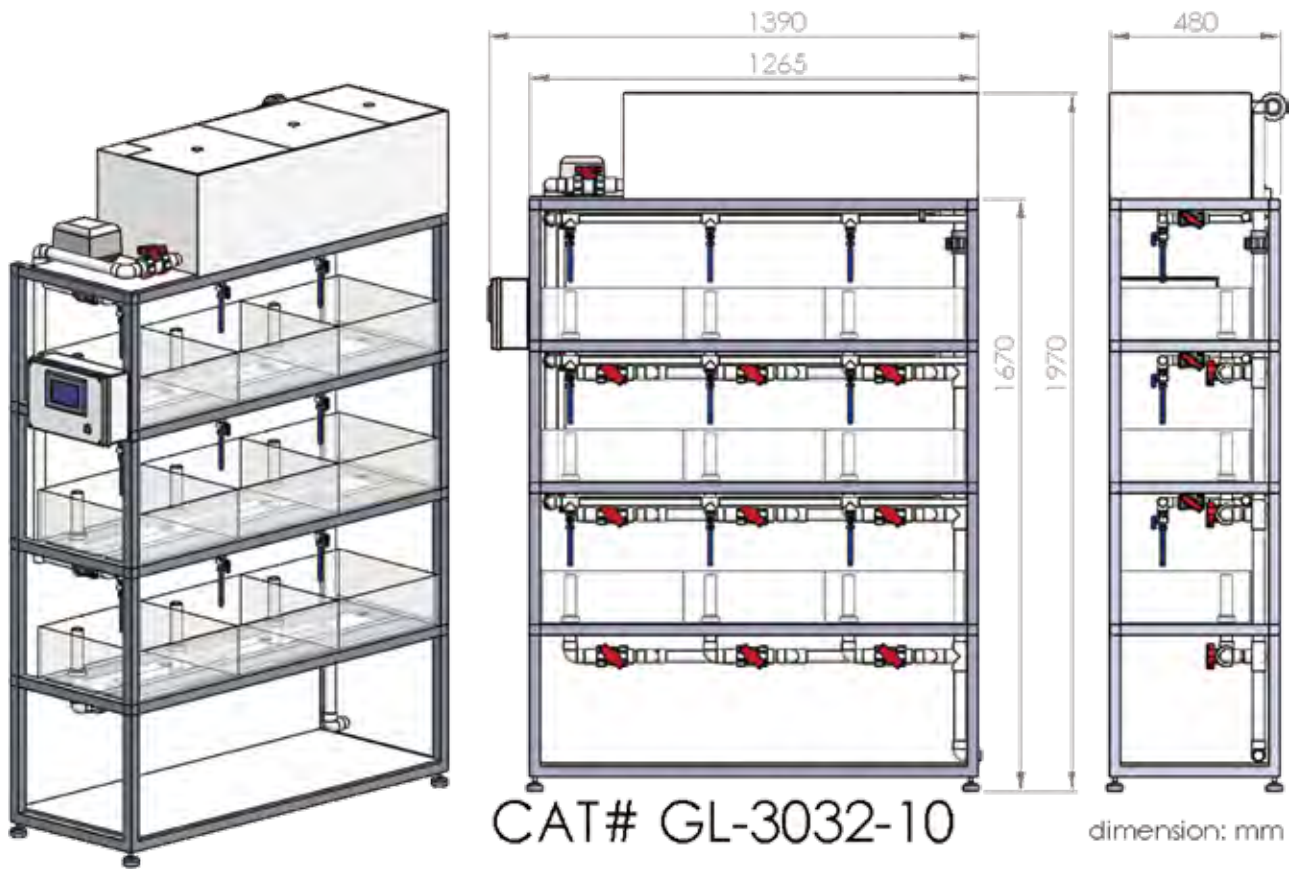

GLASS SYSTEM

The marine aquaculture environment is a more complex environment than fresh water. Seawater with the addition of mucous membranes or mucus secreted by marine fish, soft, or corals, these components are mainly organic compounds by protein and amino acid. A large amount of NO_2 , NO_3 and NH_4 will be produced if you do not remove it, and it can pollute the water quality.

A protein skimmer is used to remove waste in the form of organic compounds from the water and also oxygenates the water. Just like a filter, it is used to remove organic compounds from the water. The protein skimmer will make bubbles, which absorb impurities through the surface tension of the bubbles to separate organic waste and keep the water clean.

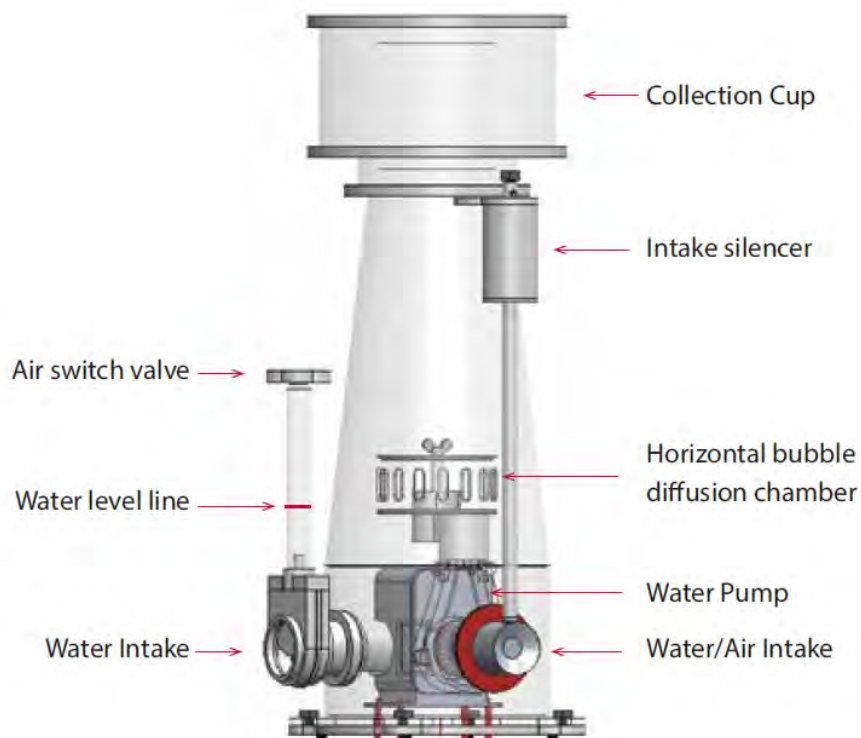
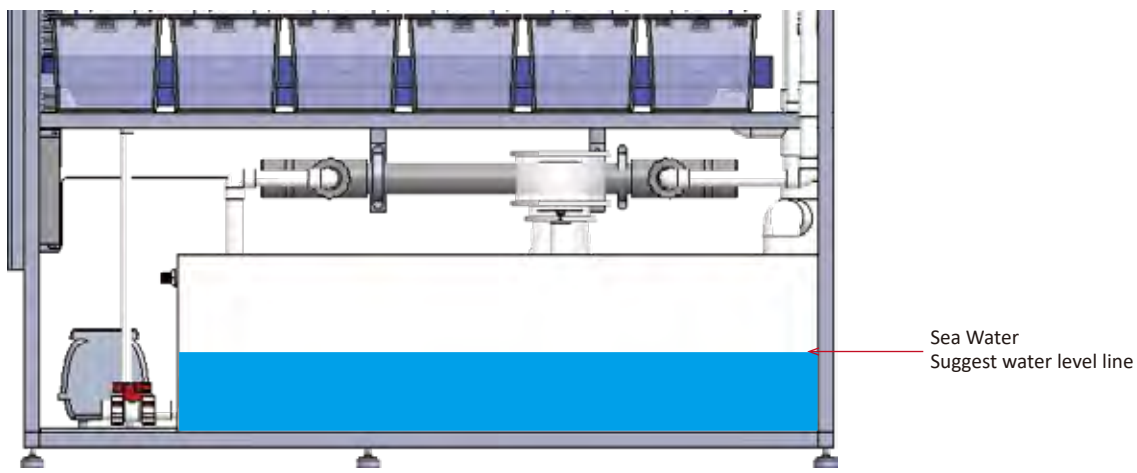

PROTEIN SKIMMER

FOR SEAWATER SYSTEM









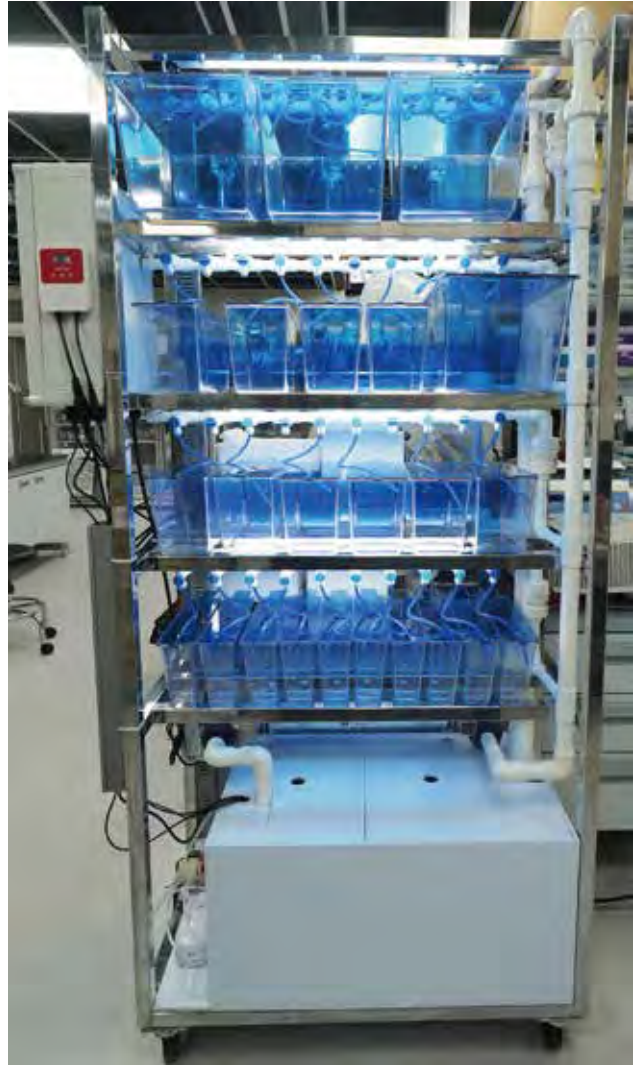





[ZOOONLAB]
ANIMAL HUSBANDRY EXPERTS



ZOONLAB GmbH

Hermannstraße 6
44579 Castrop-Rauxel
Deutschland

T: +49 (0) 23 05 - 9 73 04 - 0

F: +49 (0) 23 05 - 9 73 04 - 44

E: info@zoonlab.de

www.zoonlab.de